

User Manual v1.0



# Intelligent Speed Dome Camera



## Contents

1. Product Overview.....	2
2. Technical Parameters.....	3
3. Setting, Installation and Connection.....	5
3.1 Settings of Speed Dome Camera ID, Transfer Rate and Communication Protocol.....	5
3.1.1 Settings of Speed Dome Camera ID.....	5
3.1.2 Settings of Speed Dome Camera Communication Protocol.....	6
3.1.3 Settings of Speed Dome Camera Transfer Rate.....	7
3.2 Installation and Connection.....	7
3.2.1 Dome Camera Wall-mounted Bracket Installation .....	8
3.2.2 Dome Camera Ceiling-mounted Bracket Installation.....	9
4. Dome Camera is controlled by Keyboard.....	10
4.0 Select the Camera ID to be controlled.....	11
4.1 Set and Call Preset Position.....	11
4.1.1 Set Preset Position.....	12
4.1.2 Call Preset Position.....	12
4.1.3 Clear Preset Position.....	13
4.2 Dome Camera Cruising Function.....	13
4.2.1 Set Cruising Track.....	13
4.2.2 Run Cruising Track.....	15
4.2.3 Stop Cruising Track.....	15
4.3 Auto Scanning.....	15
4.3.1 Scanning between Two Spots.....	15
4.3.2 360° Scanning.....	15
4.3.3 Auto Scanning by Clicking [PRESET] + [ENTER] .....	15
4.4 Home Place.....	16
5. Other Functions.....	16
5.1 Object Tracking.....	16
5.2 Camera Control.....	17
5.2.1 Zoom Control.....	17
5.2.2 Focusing Control.....	17
5.2.3 Aperture Control.....	17
5.2.4 Auto BLC.....	18
5.2.5 Auto WEB.....	18
6. Camera 【OSD】Menu Setup.....	18
7. Troubleshooting.....	26
8. Appendix	
I Lightning and Surge Protection.....	27
II Cleanness of Transparent Cover.....	27
III General Knowledge of RS485.....	28
IV Relational Table of 24V AC Line Diameter and Transmission Distance.....	30
V Domestic and Overseas guage table.....	32
VI Address Coding table.....	33

## **Safety Precaution**

1. Before attempting to operate this product, please read these instructions carefully.
2. In order to avoid damaging this product, please choose the power correctly.
3. The inner elements of the Dome Camera are precise optic, electronic and mechanical parts, so wrong operations, such as heavy load and strong vibration should be avoided during transportation and installation. Otherwise, the product could be damaged.
4. The Camera should not be put on unsteady desks and brackets.
5. Avoid liquid or other things penetrating into the camera, or the camera could be damaged.
6. To avoid affecting the usage of the Dome Camera, please do not dismount its inner elements. There are no user serviceable parts inside.
7. Do abide by electrical safety standards, and use self-contained specialized power sources. Its RS-485 and Video Signal adopt TVS-level anti-thunder, so it can effectively avoid the damage caused by various pulse signals, such as instantaneous thunder below 1500w, surge, etc. RS-485 and Video Signal should be kept away from high voltage equipment or cable during transmission. Please take actions to prevent lightning strike and surge when necessary.
8. No matter the camera is in use or not, it should never be exposed to the sun or other bright objects. Otherwise, it may cause permanent damage to Camera CCD.
9. When the machine has broken down, please do not make any repairing operations unless you refer to instructions to detect faults first. If no reasons can be found, please ask professionals to conduct the maintenance work. And the professional maintenance persons should be authorized by our company.
10. Do not disassemble, or modify the system.

### **1. Product Overview**

Intelligent Dome Camera is a high-tech surveillance product combined high-performance and high-speed focused Integrated monitoring system, universal variable PTZ, multifunctional decoder, universal character generator, CPU as well as

memory chip into one. By doing so, this kind of camera not only has the functions of rapid location and continuous follow-up scanning in a row, but also achieves the real all-round and no blind spot monitoring. Besides, it can automatically adapt to the environment and the objectives that are changing in terms of distance. This camera adopts full digital control system, and its design is quite exquisite and simple, minimizing the connections between system components to improve the reliability of the system to the greatest extent, and it is very convenient for installation and maintenance. Moreover, it uses precision stepping motor to drive, achieving the effects of stable operation, rapid response and accurate positioning, and the accuracy of positioning can reach  $\pm 0.1^\circ$ . In addition, it has the intelligent functions of around scanning, pattern scanning, privacy dodging, and motion detection, alarm uploading images to the appointed mailbox or FTP server. This camera is applied to large area, and moving objects monitoring in every walk of life, such as intelligent mansion, banks, urban streets, electricity departments, airports, stations and so on.

## 2. Technical Parameters

### 2.1 7" Speed Dome Camera Technical Parameters:

Model	Intermediate Speed	High-Speed
Power Supply	AC24V $\pm$ 5%	
Operation Temperature	-20 $^\circ$ C $\sim$ +60 $^\circ$ C	
Humidity	$\leq$ 95% no dew	
Power Consumption	20W	
Communication Mode	RS485	
Baud Rate	2400/4800/9600/19200 bps	
Horizontal Rotate Speed	1 $^\circ$ $\sim$ 180 $^\circ$ (1 $\sim$ 64shift)	1 $^\circ$ $\sim$ 300 $^\circ$ (1 $\sim$ 64shift)
Horizontal Rotate Range	360 $^\circ$ rotation	
Pitching Range	90 $^\circ$	
Auto Flip Function	Auto Flip 180 $^\circ$ when Vertical 90 $^\circ$	



Auto Control Focus Speed	Auto adjust according to focus change
Two Spots Scan	At random
Two Spots Scan Speed	1~8 optional
Two Spots Scan Dwelling Time	1~60sec.optional
Preset Position Number	128
Speed to Preset Positions	1~8 optional
Every Preset Position Dwelling Time	1~60sec.optional
Cruising Group	6
Cruising Spots in every Group	16

2.2 Speed Dome Camera Lens' Technical Parameters (built in the 22X/ 35X D/N high speed focus camera)

Image Sensor	1/4"SONY SUPER HAD CCD
Signal System	NTSC/ PAL
Synchronizing System	Internal/ External
Scanning Mode	2:1 interlacing scan
Horizontal Resolution	> 480TVL
Min. Illumination	1.0Lux(color)/ 0.05Lux(BW)
Iris	Auto/ Manual
Focus Mode	Auto/ Interval/ Trigger/ Manual
Focus Sensitivity	High/ Medium/ Low
Focus Rate	22X/ 35X
Focus	3.9~85.8mm/3.5~122.5mm
Video Angel	Wide-angle 65°/narrow-angle2.7°(22X)/ wide-angle 75°/narrow-angle2° (35X)

BLC	Area detection BLC
AWB	auto-speedy/ manual/indoor/ fluorescence light/ outdoor
AGC	auto
S/N Ratio	>52dB
video Output	1.0±0.2Vpp

### 3. Settings, Installation and Connection

#### 3.1 Settings of Speed Dome Camera ID, Transfer Rate and Communication Protocol

Before installing the Dome Camera, please confirm the communication protocol, baud rate and local address code of the control host, and then the DIP-switch should be set to be in complete accordance with that in control system. Its corresponding DIP-switch settings and connecting line can be seen in picture 1:

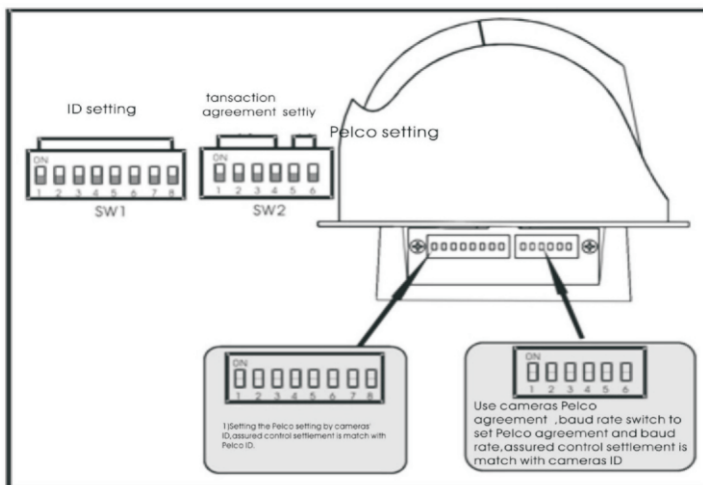

Picture 1

##### 3.1.1 Settings of Speed Dome Camera ID

Before the Intelligent Dome Camera is used, its address code should be firstly set by (SW1) 8 bit code switch on PCB board with binary system 8421 code. The largest

encode address is 255, and the number 1 indicates “on”, while the number “0” means “off”. (As it shown in picture 2): Set each Dome Camera ID code and the keyboard input of corresponding ID on LCD:



(Picture 2)

As shown in the picture above: The first switch is in the “ON” status, button on the control keyboard, and then input number “1”. Then click “Enter” again, which indicates that the ID is set as NO.1 control ID. The Dome Camera ID can be set as 001. Other addresses could be set in the same manner.

◆ The new settings will not be effective until the Dome Camera reboots.

### 3.1.2 Settings of Speed Dome Camera Communication Protocol

No.1、 2、 3、 4 on PCB board SW2 is the communication protocol settings. As it is shown in picture 3:



(Picture 3)

◆ The setting of speed dome camera communication protocol will not be effective

until the computer reboots.

### 3.1.3 Settings of Speed Dome Camera Transfer Rate

The position of 5 and 6 of the SW2 on the PCB board are used for Baud rate settings. The default value is 2400BIT/S. The Baud rate is 2400BIT/S, 4800BIT/S, 9600BIT/S, 19200BIT/S optional.

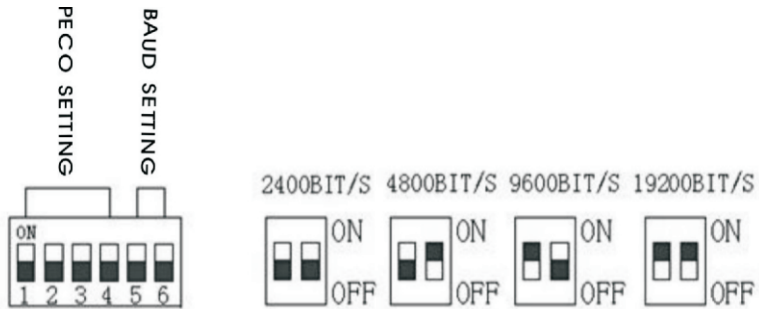

◆The setting of speed dome camera communication protocol do not work until computer reboots.

### 3.2 Installation and Connection

1. The installation and connection of the Mini Intelligent Dome Camera should be implemented under local provisions by people who own the technical qualifications of CCTV system installation.
2. Please refer to the silk print on PCB and the installation manual for the detailed information of the connection of each line.
3. Avoid direct touch to the lower cover of the dome to prevent scratches and the loss of image quality, for the cover is a high-level optical instrument.
4. To ensure the image quality, the lower cover of the dome camera should be cleaned periodically. When cleaning, take the lower cover down by holding the outer ring carefully, avoiding direct touch; the acidic sweat on one's finger might corrode the coating of the cover. And the scratches made by hard objects might also result in a blurry image. Please use a tender dry cloth or other substitutes to clean both the inner

and outer side of the cover. If the dirt is hard to clean, a neutral detergent could be used; any cleanser which is for luxury furniture can be used for the lower cover.

### 3.2.1 Dome Camera Wall-mounted Bracket Installation

#### Wall-mounted Bracket Installation

Note: The ceiling which to be installed on should be solid and with no delaminating. The bearing capacity of the installation location should be able to afford at least five times of the total weight of the Dome, frame and pedestal, in order to avoid image jitter caused by unstable installation.

- a. When installing on the wall, put up a positioning on it first.
- b. Use percussion drill to drill holes according to the marks; install four expansion bolts (M8).
- c. Put the cable through the frame holes, and set aside enough cable for connection.
- d. Fasten the frame to the wall by using four M8 nuts and four spacers, and then install the dome.

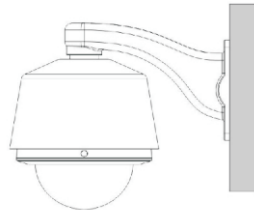
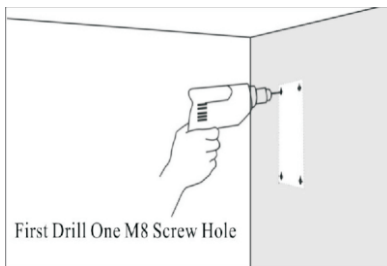

#### Outer Wire Connection

Connect the BNC video interface of Dome Camera to the arranged video cable; connect the power cord to the arranged power cord (AC24V). RS485 control wire is connected to RS485 control wire layer out.

- ◆ Ensure that the positive and negative polarity of RS485 is properly connected.

“A” represents positive pole, while “B” negative pole.

If RS485 is wrongly connected, it could not control the Dome Camera.

a. Check the polarity of the plug and socket, and the connection of cable, then power on.

b. When the self-checking starts, the Dome will turn 360°horizontally and then 90°vertically for the testing of the camera and the electrical and mechanical structure of the Dome, and turn back to the initial position by the resetting program. When the Dome totally stops, the self-checking finishes and it is ready to be under control.

### **Down Cover Installation**

- a. Wipe the dust and dirty marks on the cover with tender lint to avoid scratching the cover.
- b. Make the three screw holes of the bottom cover aim at the outer cover screw holes, and then fasten them with three screws (M3).

### **3.2.2 Dome Camera Ceiling-mounted Bracket Installation**

#### **Ceiling-mounted Bracket Installation**

Note: The ceiling which to be installed on should be solid and with no delaminating. The bearing capacity of the installation location should be able to afford at least five times of the total weight of the Dome, frame and pedestal, in order to avoid image jitter caused by unstable installation.

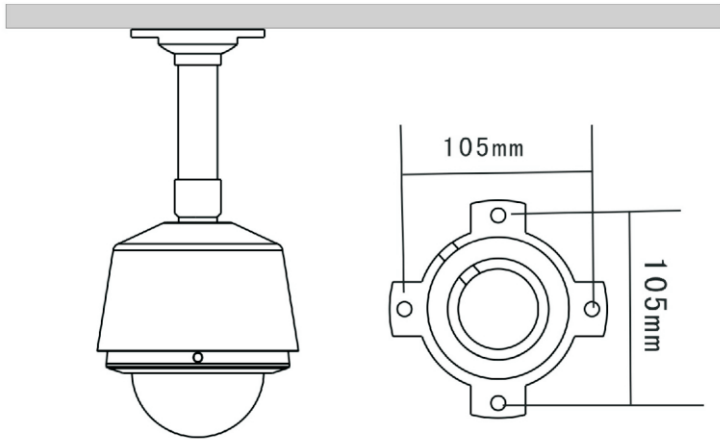

- a. The bearing capacity of the selected installation location should be able to afford at least five times of the total weight.
- b. Use percussion drill to drill holes according to the marks.
- c. Put the power cable、 communication wire and video line through the frame holes, and set aside enough cable for connection.
- d. Fasten the frame to the ceiling, and then install the dome.

#### **4. Dome Camera is controlled by keyboard**

Intelligent control and all functions can be achieved by controlling the Dome Camera with keyboard. Meanwhile, there are different operating methods for different control system platforms. Generally speaking, operating methods should be based on the manual offered by system manufacturer. Sometimes there may be some special requirements and operation methods. In this case, please feel free to contact distributors to get the useful information. (We advise you to control the Dome Camera with original keyboard to achieve optimal performance.)

Take the original keyboard of the Dome Camera manufacturer as an example. The agreement for Keyboard control is (PELCO-D、 PELCO-P) .

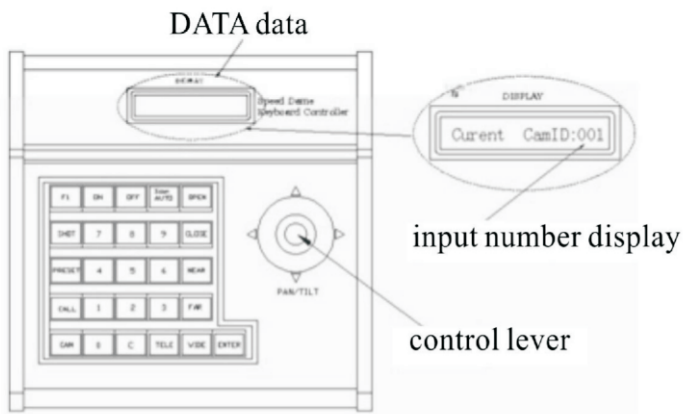

#### 4.0 Select the Dome Camera ID to be controlled

**【CAM】 + 【N】 + 【Enter】** (N: Camera Number, range 0~255)

First, click the “CAM” button, then input the number N (address) of the Dome Camera to be controlled, and then click “Enter”. When the number N is consistent with the Camera ID, the Dome Camera is ready to be controlled.

For example: Control No.2 Dome Camera

- a. Click “CAM”. (The screen shows as picture 1)
- b. Input “2”
- c. Click “Enter”. (The screen shows as picture 2)



**Picture 1**



**Picture 2**

#### 4.1 Set and Call Preset Position

Preset function is that the position parameters of horizontal angle, vertical angle, and lens focus are stored into Dome Camera with the number (1-128). When needed, these parameters can be transferred to adjust the Dome Camera to a fixed position. Users can conveniently store and call the preset positions by controlling keyboard.



This kind of camera support 128 preset positions.

**4.1.1 Set Preset Position: [PRESET] + [N] + [Enter] (N: Preset Number, range1~128)**

After the Dome Camera is adjusted to the best position through keyboard (including the selection of location、 Camera zoom、 focus、 and Iris), click the “PRESET”, and then type the number N of representing this preset position. Finally click “Enter”.

For example: Set No.2 preset position

- a. Adjust camera to a required position by moving lever, and adjust the lens’s zoom
- b. Click “PRESET” (Picture 3)
- c. Input 2 (Picture 4)
- d. Click “Enter”



**Picture 3**



**Picture 4**

◆ When set preset positions for distant objects, you can focus the image manually. That is to say, when adjust lens at a distance, you can adjust and store the best images by controlling “FAR” / “NEAR” buttons on the keyboard. By doing so, image blurring could be avoided.

**4.1.2 Call Preset Position: [CALL] + [N] +ENTER] (N: the number of preset position)**

The function of calling preset positions is adjusting camera to the previous position. Click “CALL” firstly, and then input the preset position number to be called. Lastly, click “ENTER”. At this time, the camera is back to the original position.

For example: Call No.2 preset position

- a. Click “CALL” button. (Refer to the picture 5)
- b. Input No. 2 ( Refer to the picture 6)
- c. Click “ENTER” button.



**Picture 5**



**Picture 6**

#### **4.1.3 Clear Preset Position: [PRESET] + [N] + [OFF] (N: the number of preset position)**

Clearing preset position is to delete the stored preset location in the Dome Camera.

For example: Clear No.2 preset position.

- a. Click “PRESET” button. (Refer to the picture 7)
- b. Input No.2. (Refer to the picture 8)
- c. Click “OFF” button.



**Picture 7**



**Picture 8**

#### **4.2 Dome Camera Cruising Function**

Auto cruising is an important feature for Dome Camera. This function can arrange preset positions to the cruising queue in a required order. Under an external command, the Dome Camera can automatically visit back and forth at a specified interval time in sequence. Altogether 8 cruising tracks can be set, and each track involves 16 preset positions.

##### **4.2.1 Set Cruising Track: Enter and edit cruising tracks.**

Set the cruising tracks of Dome Camera with keyboard. Click “SHOT” button firstly, then input the number of cruising track. Next, click “ON” button to enter a cruising tracks setting state. After that, click “TELE” button enter the next step, and if you click the “WIDE” button, you can go back to the last step. Each track involving 16 preset positions, and the running speed and dwelling time upon each point can be edited by controlling “TELE/WIDE” buttons.

For example: The first preset position in the first cruising track is set as the No.1

preset position. Its running speed is Level 5 and dwelling time is 3 seconds.

- a. Click “SHOT” button.( Refer to the picture 9)
- b. Press 1 on the number pad to set cruising track.
- c. Click “ON” button is set to enter the track. (Refer to the picture 10)



**Picture 9**

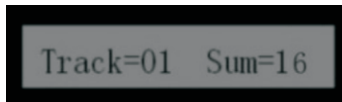

**Picture 10**

- d. Click “TELE” button.
- e. Press 1 on the number pad to set preset position 1. (Refer to the picture 11)
- f. Click “TELE” button.
- g. Press 5 on the number pad to set running speed. (Refer to the picture 12)



**Picture 11**



**Picture12**

- h. Click “TELE” button.
- i. Press 3 on the number pad to set dwelling time. (Picture 13)
- j. Click “TELE” button to set the second preset position. (Picture 14)



**Picture13**



**Picture14**

NOTE: Click “OFF” button to save settings and back to last step after the preset positions settings are finished. If you rotate the level or press other buttons, the settings could not be saved.

- Altogether 6 cruising tracks can be set. Each track involving 16 preset locations.( Preset position at random is 1—128).
- 1~60 secs dwelling time for each preset location can be set, and level 1~8 preset location speed to each point can be set as well.

#### **4.2.2 Run Cruising Track: [SHOT] + [N] + [Enter] (N: the number of Cruising track, 1~6)**

For example: Running the first cruising track.

- a. Click “SHOT” button.
- b. Press 1 on the number pad to activate the first cruising track.
- c. Click “Enter” button.

#### **4.2.3 Stop Cruising Track: [SHOT] + [OFF]/ Use level**

#### **4.3 Auto scanning (2-spot scanning, 360° scanning)**

The Auto Scanning function enables that the Dome Camera can scan randomly between 2 selected locations, or can do 360° scanning. While scanning, it will automatically run with matched speed according to the lens’ focal length.

##### **4.3.1 Scanning between Two Spots**

- a. Move to the start point (point A) by using level. Then click “PRESET” button, and input 101 on the number pad. Finally click “ENTER” button.
- b. Move to the end point (point B) by using level. Then click “CALL” button. After that, input 101 on the number pad. At last, click “ENTER” button.
- c. Click “CALL” button. Then input 103 on the number pad. At last, click “ENTER” button.
- d. If you want to stop scanning, please use the level.

##### **4.3.2 360° Scanning: [CALL] + [106] + [Enter]**

- a. Click “CALL” button.
- b. Input 106
- c. Click “ENTER” button.
- d. If you want to stop scanning, please use the level.

##### **4.3.3 Auto Scanning by clicking [PRESET] + [ENTER]**

Click [PRESET] + [102] + [ENTER] to scan automatically at a low speed.

Click [CALL] + [102] + [ENTER] to scan automatically at an intermediate speed.

Click [PRESET] + [103] + [ENTER] to scan automatically at a high speed.

Note: 2-spot scanning can be set in the same way.

#### 4.4 Home Place

The Home Place function is that the Dome Camera will return to No.1 preset location automatically when no operation is done in a period of time. The Home Place function of Dome Camera can be activated through keyboard.

##### 4.4.1 Start Home Place Function: [PRESET] + [107] + [ENTER]

- a. Click “CALL” button (The screen shows as picture 15)
- b. Input 107 on the number pad to activate the mode. (Picture 16)
- c. Click “ENTER” button.



**Picture 15**



**Picture16**

##### 4.4.2 Stop Home Place Function: [CALL] + [107] + [ENTER]

- a. Click “CALL” button (Picture 17)
- b. Input 107 on the number pad to activate the mode. (Picture 18)
- c. Click “ENTER” button



**Picture17**



**Picture18**

## 5. Other Functions

### 5.1 Object Tracking

Users can use the control lever on the control keyboard to move the Dome camera up and down, or left and right to track the moving object or change the field of vision, and change the visual angle or the image of the object by adjusting the focal length. On the preset condition of auto-focusing and auto-aperture, the camera can adjust itself quickly to get a clear view of the object according to the environment during its moving around.

#### \* Focal Length/Rotating Speed Auto-matching Technology

When manual adjusting the Dome camera with a long focal distance, the high rotating speed of camera may cause image loss even touch the control lever slightly. Considering the humanization, this ball camera is designed to auto-adjust both the horizontal and vertical rotating speed according to the focal length which makes the manual operation of tracking easier.

#### **\* Auto-overturn**

When the operator turns the scene to the bottom (vertically) and continues pressing the control stick, the camera will turn 180° horizontally and then upturn 90° to get a back view, which provides a 180° whole-course continuous monitor.

### **5.2 Camera Control**

#### **5.2.1 Zoom Control**

Users can zoom in or out by using the [WIDE] and [TELE] key on the control keyboard to get an overall perspective or a close shot.

#### **5.2.2 Focusing Control**

Auto-focusing is the default setup. When zooming, the camera will auto-focus on the center of the view to get a clear picture. In particular situation, users can manually focus by using the [NEAR] and [FAR] key to get an expectant view.

#### **◆Camera cannot auto-focus on following conditions:**

- a. The object is not in the center of the picture;
- b. The objects from both far and near spots cannot be visually clear simultaneously;
- c. The object emits strong light, such as neon light and spotlight;
- d. The object is behind a glass with water dew or dust on it;
- e. The object moves very fast;
- f. The object is large and monotonous, like a wall;
- g. The object is too dark or blurry itself.

#### **5.2.3 Aperture Control**

●Auto-iris is the default setup. This function can auto-detect the light condition of the environment and adjust accordingly to ensure the brightness of the output picture stable.

●Users can manually adjust the aperture to get a needed brightness by using the control keyboard.

●Users can restore the auto-iris function by using the control keyboard (**Note: auto-iris is suggested**).

**Note: When switching the aperture control to manual function, the current control position will be locked, and it will not restore to auto-aperture function automatically, even the scene changes. To restore the auto function, users need to operate the control lever or give a control order.**

#### **5.2.4 Auto BLC**

The camera will divide the scene into six areas to realize the auto back light compensation. In a bright environment, it will auto-compensate the dark object and adjust the lighting for the bright background, in order to avoid obtaining an over-bright picture without visualizing the dark object instead of a clear image.

#### **5.2.5 Auto WEB**

Automatically adjust according to the lighting of the surroundings to recover the true colors.

### **6. Camera 【OSD】 Setup**

**Some modules do not support some of the functions.**

The Dome Camera menu could be set with keyboard, but some of them could not be set.

The following【OSD】setup is only applied to the standard cameras that the dome camera producer manufactured.

#### **6.1. 0 Enter Camera 【OSD】**

- a. Click “PRESET” button
- b. Input 112
- c. Click “Enter” button, and then exit.

#### **6.1. 1 Quit from Camera 【OSD】**

- a. Click “CALL” button
- b. Input 112
- c. Click “Enter” button, and then exit.

Notice: If you want to go back to the main menu, please click the last option “BACK TO MENU” or click [CALL] + [112] when you stay in the second submenu. After that, please carry out 6.1.1 operation to drop out OSD control menu.

## 6.2.0 Camera 【OSD】 Menu Items

Menu includes main menu and submenu. When entering the Camera【OSD】, you can open the selected items by controlling “UP”、“DOWN”、“LEFT”、“RIGHT” buttons on the keyboard lever. **(The flickering items indicate that they have been selected.)**

- Main Menu displays 6 options.

MAIN MENU

INITIAL	GENERAL	FOCUS
EXPOSURE	PRIVACY	WB

Menu Operation

### ■ INITIALSET

- Make functions restore to the factory default.

### ■ LENS AUTOINIT

- Lens auto initialization function can be achieved by counting the number of lens zoom. You can select 5K、10K、15K、20K、EXCE and OFF. Regrouping makes images clearer.

### ■ GENERAL

- Set Camera’s normal operations
- Press “DOWN” to enter the submenu.



GENERAL	
CAMERA ID	OFF
MIRROR	OFF
SHARPNESS	HIGH
COLOR SUPPRESS	OFF
LUX LEVEL	LOW
APERTURE SUPPRESS	OFF
	NEXT
HIGHLIGHT SUPPRESS	OFF
THRESHOLD LEVEL	000
BAUDRATE	9600
BACK TO MENU	←

#### 1. CAMERAID

- Show the Camera's identification number.
- The ID of Camera No.001-255 can be set by using NEAR/ LEFT、 FRA/ RIGHT .

#### 2. MIRROR

- Mirroring can be done to the images taken by the Camera.

#### Menu Operations

Add menu operations

#### 3. SHARPNESS

- Adjust image sketch, and High/ Middle/ Low can be set.

#### 4. COLORSUPPRESS

- Pictures can be changed into white and black pictures in a certain dark circumstance, and improve the signal noise ratio.

#### 5. LUXLEVEL

- Camera can be adjusted by using LEFT/ RIGHT to control the electrical level high/ middle/ low.

#### 6. APERTURESUPPRESS



- Set the running time (001~120sec.) by controlling the NEAR/FAR button.

#### 1.4 MANU

- Choose this mode to exit. Then adjust focus by “LEFT/ RIGHT” button.

### MENU OPERATIONS

#### 2. SENSITIVITY

- Adjust the auto focusing sensitivity.

#### 3. NEAR FOCUS LIMIT

●The full-view auto-focus system of the Camera can continuously take pictures, from close-up (the object is about 1cm away) to infinity. Make sure that the focus is in the recent locations. Users can adjust close focus limited parameters to achieve the fastest focus speed. For example, if the subjects to be taken are beyond 5M, the close focus limiest parameter can be set above 006.

#### Close Focus Limited Specifications:

000	001	002	003	004	005	006	007	008
1cm/1m	10cm/1m	50cm/1m	1m/1m	2m/2m	3m/3m	5m/5m	10m/10m	infinity

#### 4. BACK TO MENU

AE MODE AL

BACKLIGHT OFF

**BACKTOMENU** ←

#### ■ AE MODE( Shutter setting)

1. AE [Auto shutter]
2. AI [Auto aperture]
3. MANU [Manual setting]
4. SHUTTER [Manual setting]

●The range of shutter speed is 1/ 50 (1/60)、1/120 (1/100)、1/ 250、 1/ 500、1/ 1K、1/ 2K、 1/ 4K、1/10K 、1/ 100K

#### 5. IRIS

The range of iris is CLOSE, F1.6-F16.

## 6. AGC

- The range of AGC is 5db\ 13db\ 22db\ 30db.

FLICKERLESS MUST BE OFF

- WARNING: FLICKERLESS MUST BE OFF.

### ■ FLICKERLESS

- The default options are: Normal, Cable Control, Steady and Off.

### ■ BACK TO MENU

### ■ BACKLIGHT OFF (Backlight setting)

## 1. SENS

GAIN

- Set backlight sensitivity
- Gain control can be set in the range of 0~255 through LEFT/ RIGHT.

## 5. AREA      Checking area

- 2.1 OFF              Backlight off
- 2.2 AREA1          Set middle window backlight
- 2.3 AREA2          Set below 1/3 window backlight
- 2.4 AREA3          Set left middle window backlight
- 2.5 AREA4          Set right middle window backlight
- 2.6 AREA5          Set upper 1/3 window backlight

\* If the subjects that you want to take are so dim due to the strong backlight, you can set the BLC "ON". Then Camera will balance light automatically to make images clearer. This function could not be applied to the situation that the objects are too small comparing with the background.

## MENU OPERATIONS

### 1. UNWEIGHTED LEVEL

- Set Backlight Weighted Average

- 0~15 optional

## 2. BACK TO MENU

AEMODEMUSTBEAE

- WARNING: AE MODE MUST BE AE.

MENU OPERATIONS

### ■ PRIVACY

MASKSET

MASKNUMBER <1—8>

MASKSET OFF

H. STARTPOSITION

H. ENDPOSITION

V. STARTPOSITION

V. ENDPOSITION

MASKCOLOR HOLD

BACKTOMENU ←

MUSTOPERATEONMANUFCS

### 1. MASK NUMBER

- 8 areas can be set.

MASK SET [Mosaic window setting]

H. STARTPOSITION [Horizontal start position]

H. ENDPOSITION [Horizontal end position]

V. STARTPOSITION [Vertical start position]

V. ENDPOSITION [Vertical end position]

MASKCOLOR [Mosaic window color]

- Optional colors for MASK are: HOLD, GREY, WHIT, BLAC, RED, ORAN, YELL, GREE, BLUE and PURP.

### 1. BACK TO MENU

- WARNING: Must be on manual focus model.

■ WBC MODE

WBCMODE

WBCMODE

ANTI-COLORMUSTBEOFF

**BACKTOMENU**



1. PUSH

Adjust BLC automatically and quickly.

2. MANU

2.1 WBC ADDITION

● Chose this option if you want to add / reduce red or blue correction.

3. INDR

Set temperature is about 3200K..

4. FLUO

Set temperature is about 4700K.

5. OUTD

Set temperature is about 9500K.

6. AUTO

Adjust image color automatically according to the effective illumination.

7. BACK TO MENU

\* After return to the main menu, click [CALL] button, then input [112], lastly click [ENTER], then you can go back to OSD control menu.

Protocol、 Transmission rate and ID should be set correctly when other control equipments are used to control the Dome Camera. Because different manufacturers have different ID codes, sometimes the Camera ID is needed to be set as "ID+1". For example, the Dome Camera could not be controlled by DVR until its ID is "2". The rest can be done in the same manner.

## 7. TROUBLESHOOTING

Problems	Possible reasons	Solutions
No action, no pictures when power is on	Power supply damaged or under power	Replace
	Wrong connection of power	Correct
	Project line fault	Eliminate
Abnormal self-check. Images with motor noise	Mechanical failure	Recondition
	Camera inclined	Reinstall
	Power supply not enough	Replace required power supply; Put power supply close to Dome Camera
Normal self-check, but no images	Wrong connection of video	Correct
	Bad connection of video	Eliminate
	Camera damaged	Replace
Normal self-check, but out of control	Wrong connection of signal control cable	Correct
	Dome ID setup is wrong	Reselect
	Protocol or communication baud rate is not matched	Adjust protocol to match with the controller, and power on again
Unstable images	Bad connection of video	Press to connect well
	Power not enough	Replace
Dome Camera out of control	Self-check error	Power on again
	Bad connection of control cable	Eliminate
	Bad host operations	Power on again
	Overload or communication distance too far	Add code distributor

## **8. Appendix 1: Lightning and Surge Protection**

The product adopts TVS plate lightning protection technology, which is effective for avoiding the damage of equipments from pulse signal under 1500W HP, such as those from instant lightning or surge. However, for outdoor installation, necessary protection must be adopted according to the situation on condition that the electric safety must be guaranteed.

- The transmission line must be at least 50 meters away from high-voltage equipments and cable; try to arrange the line along the eaves.
- The underground sealed steel tube arrangement must be adopted in open area, and the single point earthing must be used. The overhead ground arrangement is absolutely forbidden.
- In the intense thunderstorm or high induced voltage area (e.g. High-Voltage Junction Box), such methods as the installation of extra superpower lightning protection equipments or lightning rod must be adopted.
- The design of outdoor device and the lightning protection and earthing of line must meet the requirements of the building's lightning protection, and be in accordance with relevant national and industrial standards.
- The system must be earthed with equal potential. The earthing device must meet the requirements of both anti-interference and electric safety, and mustn't connect to, or mix with the zero line of any strong power grid. When the system adopts the earth connection alone, the impedance should be no more than  $4\Omega$ , and section surface should not exceed  $25\text{mm}^2$ .

## **Appendix II: Cleanness of Transparent Cover**

- To ensure the image quality, the lower cover of the dome camera should be cleaned periodically
- When cleaning, take the lower cover down by holding the outer ring carefully, avoiding direct touch; the acidic sweat on one's finger might corrode the coating of the cover. And the scratches made by hard objects might also result in a blurry



image.

- Please use a tender dry cloth or other substitutes to clean both the inner and outer side of the cover.
- If the dirt is hard to clean, a neutral detergent could be used; any cleanser which is for luxury furniture can be used for the lower cover.

## Appendix III: General Knowledge of RS485

### 1. Basic Characteristics of RS485

According to its standard, RS485 industrial bus is a half-duplex C-bus of special impedance  $120\ \Omega$ , whose largest loading capacity is 32 payloads. (Including master device and controlled device)

### 2. The transmission distance of RS 485

Band Rate	Maximum Transmission Distance
2400Bps	1800m
4800 Bps	1200m
9600 Bps	800m

### 3. Connection mode and terminal resistance

a) RS 485 industrial bus standard requires that daisy chained ways should be adopted among devices with  $120\ \Omega$  terminal resistors at both ends. The connection (picture 26) can be simplified as that in picture 27, but “D” distance should not be more than 7m.

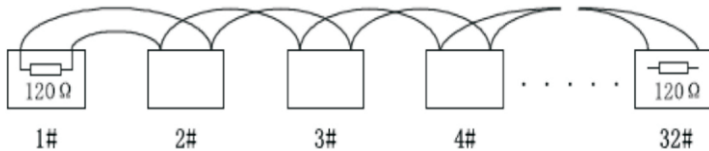

Picture 26

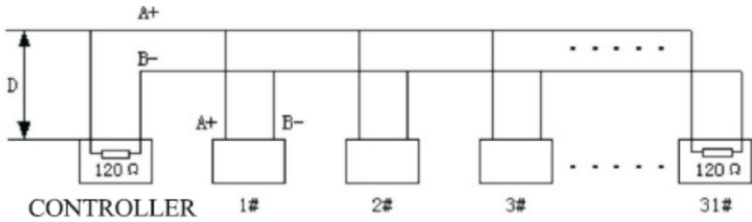

**Picture 27**

A) The connection mode of device terminal 120Ω: (As picture 27) there are device terminal resistances on controller board, which have two connection modes. Picture 43 shows the factory default connection mode. In this case, the wire jumper cap on controller board is connected to the position between 2-3 sockets without 120Ω resistor connected. When 120Ω resistor is required, the wire jumper cap on controller board should be pulled out of 2-3 sockets to plug into the 1-2 ones. Then the 120Ω resistor is connected to circuits.

#### **4. Some problems in application**

Star connection is always adopted by users in application. In this situation, the terminal resistors should be on the 1# and 15# (as it is shown in picture 28) of two devices with maximum line distance. However, this connection type is not consistent with the operating requirements of RS 485 industrial standard, so the problems, like signal reflex and the decrease of anti-jamming capability, easily occur, which may reduce the reliability of controlled signal. The phenomenon reflected is that balling machine is completely or discontinuously out of control, or that it cannot stop running. To solve these problems, we propose to use MC 2080 Rs485 distributor, because this product can convert the star connection mode to that one accord with RS 485 industrial standard, avoiding problems to improve the reliability. (Picture 29)

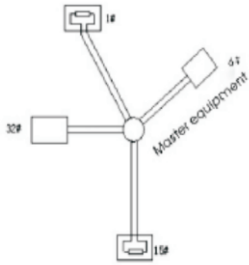

(Picture 28)

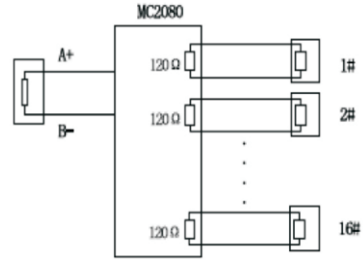

(picture 29)

## Appendix IV

### Relational Table of 24V AC Line Diameter and Transmission Distance

The maximum transmission distance is recommended in the situation that the line diameter is fixed and 24V AC voltage wastage rate is below 10%. As for the AC main power supply devices, their maximum allowable voltage wastage rate is 10%. For example, a device with an 80 VA rated power is installed in a place 35 feet away from the transformer, then the required minimum line widths should be 0.8000 mm.

Distance feet(m) Power	Wire radii(mm)			
	0. 8000	1. 000	1. 250	2. 000
10	283 (86)	451 (137)	716 (218)	1811 (551)
20	141 (42)	225 (68)	358 (109)	905 (275)
30	94 (28)	150 (45)	238 (72)	603 (183)
40	70 (21)	112 (34)	179 (54)	452 (137)
50	56 (17)	90 (27)	143 (43)	362 (110)
60	47 (14)	75 (22)	119 (36)	301 (91)
70	40 (12)	64 (19)	102 (31)	258 (78)
80	35 (10)	56 (17)	89 (27)	226 (68)
90	31 (9)	50 (15)	79 (24)	201 (61)
100	28 (8)	45 (13)	71 (21)	181 (55)
110	25 (7)	41 (12)	65 (19)	164 (49)
120	23 (7)	37 (11)	59 (17)	150 (45)
130	21 (6)	34 (10)	55 (16)	139 (42)
140	20 (6)	32 (9)	51 (15)	129 (39)
150	18 (5)	30 (9)	47 (14)	120 (36)
160	17 (5)	28 (8)	44 (13)	113 (34)
170	16 (4)	26 (7)	42 (12)	106 (32)
180	15 (4)	25 (7)	39 (11)	100 (30)
190	14 (4)	23 (7)	37 (11)	95 (28)
200	14 (4)	22 (6)	35 (10)	90 (27)

## Attachment V : Domestic and overseas gauge table

Metric naked wire radii (mm)	Approximately American radii AWG	Approximately England radii SWG	naked wire cross section area (mm <sup>2</sup> )
0.050	43	47	0.00196
0.060	42	46	0.00283
0.070	41	45	0.00385
0.080	40	44	0.00503
0.090	39	43	0.00636
0.100	38	42	0.00785
0.110	37	41	0.00950
0.130	36	39	0.01327
0.140	35		0.01539
0.160	34	37	0.02011
0.180	33		0.02545
0.200	32	35	0.03142
0.230	31		0.04115
0.250	30	33	0.04909
0.290	29	31	0.06605
0.330	28	30	0.08553
0.350	27	29	0.09621
0.400	26	28	0.1237
0.450	25		0.1602
0.560	24	24	0.2463
0.600	23	23	0.2827
0.710	22	22	0.3958
0.750	21		0.4417
0.800	20	21	0.5027
0.900	19	20	0.6362
1.000	18	19	0.7854
1.250	16	18	1.2266
1.500	15		1.7665
2.000	12	14	3.1420
2.500			4.9080
3.000			7.0683

## Appendix VI: Address coding table

binary code	address	binary code	address	binary code	address
0000001	1	00010111	23	00101101	45
0000010	2	00011000	24	00101110	46
0000011	3	00011001	25	00101111	47
0000100	4	00011010	26	00110000	48
0000101	5	00011011	27	00110001	49
0000110	6	00011100	28	00110010	50
0000111	7	00011101	29	00110011	51
0001000	8	00011110	30	00110100	52
0001001	9	00011111	31	00110101	53
0001010	10	00100000	32	00110110	54
0001011	11	00100001	33	00110111	55
0001100	12	00100010	34	00111000	56
0001101	13	00100011	35	00111001	57
0001110	14	00100100	36	00111010	58
0001111	15	00100101	37	00111011	59
0010000	16	00100110	38	00111100	60
0010001	17	00100111	39	00111101	61
0010010	18	00101000	40	00111110	62
0010011	19	00101001	41	00111111	63
0010100	20	00101010	42	01000000	64
0010101	21	00101011	43	01000001	65
0010110	22	00101100	44	01000010	66
binary code	address	binary code	address	binary code	address
01000011	67	01101101	109	10010111	151
01000100	68	01101110	110	10011000	152
01000101	69	01101111	111	10011001	153
01000110	70	01110000	112	10011010	154
01000111	71	01110001	113	10011011	155

01001000	72	01110010	114	10011100	156
01001001	73	01110011	115	10011101	157
01001010	74	01110100	116	10011110	158
01001011	75	01110101	117	10011111	159
01001100	76	01110110	118	10100000	160
01001101	77	01110111	119	10100001	161
01001110	78	01111000	120	10100010	162
01001111	79	01111001	121	10100011	163
01010000	80	01111010	122	10100100	164
01010001	81	01111011	123	10100101	165
01010010	82	01111100	124	10100110	166
01010011	83	01111101	125	10100111	167
01010100	84	01111110	126	10101000	168
01010101	85	01111111	127	10101001	169
01010110	86	10000000	128	10101010	170
01010111	87	10000001	129	10101011	171
01011000	88	10000010	130	10101100	172
01011001	89	10000011	131	10101101	173
01011010	90	10000100	132	10101110	174
01011011	91	10000101	133	10101111	175
01011100	92	10000110	134	10110000	176
01011101	93	10000111	135	10110001	177
01011110	94	10001000	136	10110010	178
01011111	95	10001001	137	10110011	179
01100000	96	10001010	138	10110100	180
01100001	97	10001011	139	10110101	181
01100010	98	10001100	140	10110110	182
01100011	99	10001101	141	10110111	183
01100100	100	10001110	142	10111000	184
01100101	101	10001111	143	10111001	185
01100110	102	10010000	144	10111010	186

01100111	103	10010001	145	10111011	187
01101000	104	10010010	146	10111100	188
01101001	105	10010011	147	10111101	189
01101010	106	10010100	148	10111110	190
01101011	107	10010101	149	10111111	191
01101100	108	10010110	150	11000000	192
<b>binary code</b>	<b>address</b>	<b>binary code</b>	<b>address</b>	<b>binary code</b>	<b>address</b>
11000001	193	11010110	214	11101011	235
11000010	194	11010111	215	11101100	236
11000011	195	11011000	216	11101101	237
11000100	196	11011001	217	11101110	238
11000101	197	11011010	218	11101111	239
11000110	198	11011011	219	11110000	240
11000111	199	11011100	220	11110001	241
11001000	200	11011101	221	11110010	242
11001001	201	11011110	222	11110011	243
11001010	202	11011111	223	11110100	244
11001011	203	11100000	224	11110101	245
11001100	204	11100001	225	11110110	246
11001101	205	11100010	226	11110111	247
11001110	206	11100011	227	11111000	248
11001111	207	11100100	228	11111001	249
11010000	208	11100101	229	11111010	250
11010001	209	11100110	230	11111011	251
11010010	210	11100111	231	11111100	252
11010011	211	11101000	232	11111101	253
11010100	212	11101001	233	11111110	254
11010101	213	11101010	234	11111111	255